

**Operating Instructions**  
**Liquid ring vacuum pumps**  
LR 060-H06, LR 061-H16

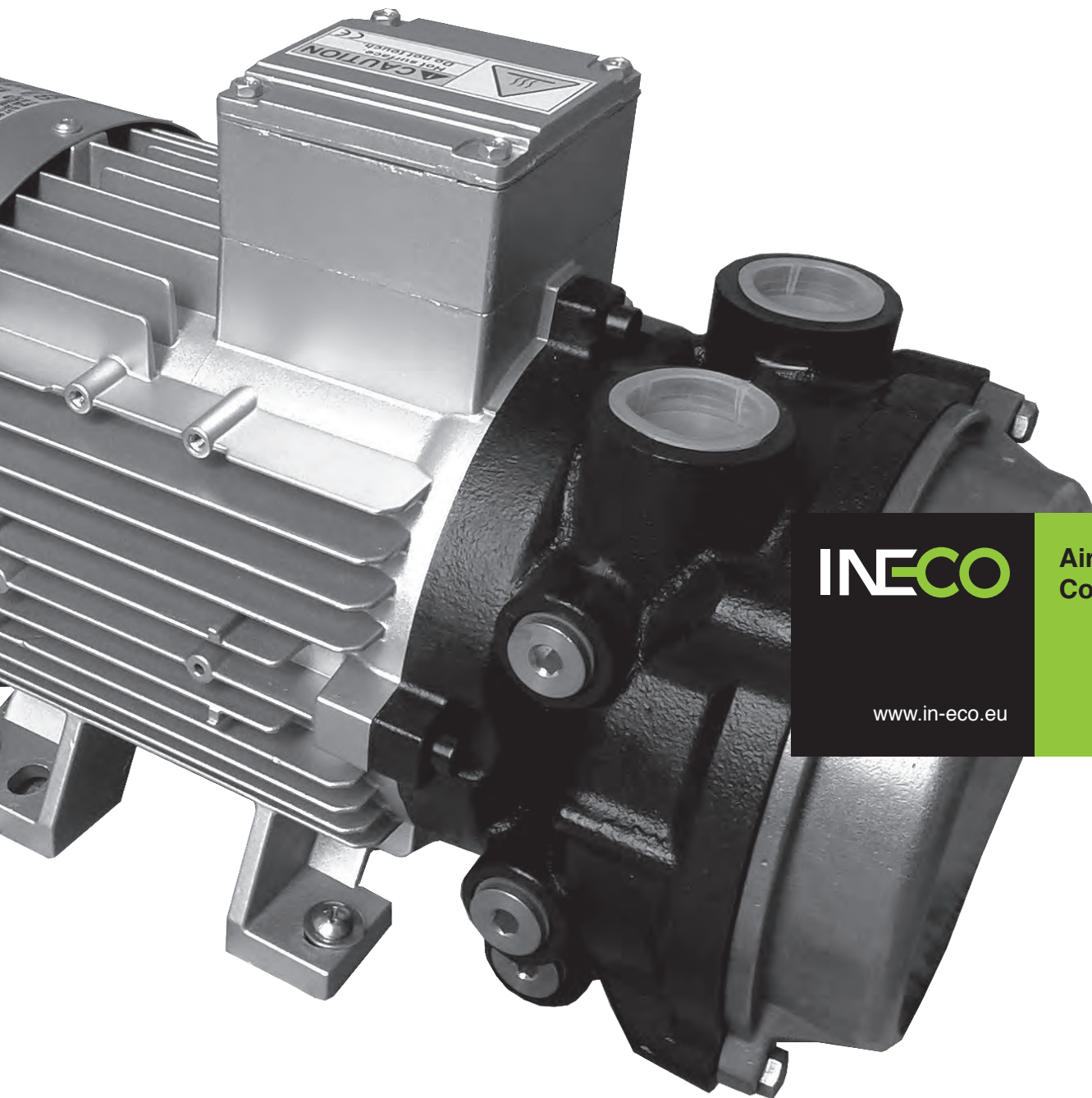

**INECO**

**Air and Vacuum  
Components**

[www.in-eco.eu](http://www.in-eco.eu)



## Contents

<b>1 Safety</b>	<b>06</b>
1.1 Definitions	06
1.2 Safety alert symbol	06
<b>2 Intended Use</b>	<b>08</b>
<b>3 Intended Use</b>	<b>08</b>
<b>4 Technical Data</b>	<b>09</b>
4.1 Mechanical data	09
4.2 Operating conditions	10
<b>5 Description of Vacuum Pump/Compressor</b>	<b>12</b>
5.1 Design and principle	12
5.2 Operating method	12
5.3 Operating modes	13
5.3.1 Self-priming operation	13
5.3.2 Operation with operating-liquid feed	13
<b>6 Transport and Handling</b>	<b>14</b>
<b>7 Installation</b>	<b>15</b>
7.1 Installation	15
7.2 Electrical connection (motor)	16
7.3 Connecting pipes/hoses (vacuum pump/compressor)	17
7.3.1 Inlet connection	18
7.3.2 Discharge connection	18
7.3.3 Operating-liquid port	18
<b>8 Commissioning</b>	<b>19</b>
8.1 Preparation and start-up	19
8.2 Self-priming operation	20
8.3 Operation with operating-liquid feed	21
<b>9 Operation</b>	<b>23</b>
9.1 Self-priming operation	23
<b>10 Shut-Down and Longer Standstills</b>	<b>24</b>
10.1 Draining	24
10.2 Preparing for longer standstill	24
10.3 Storage conditions	25

<b>11 Servicing</b>	<b>25</b>
11.1 Maintenance	26
11.2 Repairs/troubleshooting	28
11.3 Spare parts	30
11.3.1 Ordering IN-ECO spare parts	30
11.3.2 Ordering standardized parts	30
11.4 Service/After-sales service	30
11.5 Decontamination and Declaration of Clearance	30
<b>12 Disposal</b>	<b>30</b>
<b>13 Accessories</b>	<b>31</b>
13.1 Flanges	31
13.2 Non-return valve	31
13.3 Gas ejector	32
13.4 Liquid separator	33
13.5 Cavitation protection	34
<b>14 Exploded View with Parts List</b>	<b>36</b>
14.1 Parts list	36
14.2 Exploded view	37
<b>15 Limited standard warranty</b>	<b>39</b>
<b>16 Waste disposal</b>	<b>39</b>



# 1 Safety

## 1.1 Definitions

To point out dangers and important information, the following signal words and symbols are used in these operating instructions:

## 1.2 Safety alert symbol

The safety alert symbol is located in the safety precautions in the highlighted heading field on the left next to the signal word (DANGER, WARNING, CAUTION). Safety precautions with a safety alert symbol indicate a danger of injuries. Be sure to follow these safety precautions to protect against injuries or death! Safety precautions without a safety alert symbol indicate a danger of damage.

## 1.3 Signal words

**DANGER**  
**WARNING**  
**CAUTION**  
**NOTICE**  
**NOTE**

The signal words are located in the safety precautions in the highlighted heading field. They follow a certain hierarchy and indicate (in conjunction with the safety alert symbol, see Chapter 1.2) the seriousness of the danger and the type of warning.

See the following explanations:

<b>⚠ DANGER</b>	<b>⚠ WARNING</b>	<b>⚠ CAUTION</b>
<b>Danger of injuries.</b> Indicates an imminently hazardous situation, that will result in death or serious injury if the corresponding measures are not taken.	<b>Danger of injuries.</b> Indicates a potentially hazardous situation, that could result in death or serious injury if the corresponding measures are not taken.	<b>Danger of injuries.</b> Indicates a potentially hazardous situation, that may result in minor or moderate injury if the corresponding measures are not taken.
<b>CAUTION</b>	<b>CAUTION</b>	<b>NOTICE</b>
<b>Danger of damage.</b> Indicates a potentially hazardous situation that may result in property damage if the corresponding measures are not taken.	<b>Danger of damage.</b> Indicates a potentially hazardous situation that may result in property damage if the corresponding measures are not taken.	<b>Indicates a possible disadvantage, i.e. undesirable conditions or consequences can occur if the corresponding measures are not taken.</b>
		<b>NOTE</b>
		<b>Indicates a possible advantage if the corresponding measures are taken; tip.</b>

## 1.4 Všeobecné bezpečnostné pokyny



<b>⚠ WARNING</b>	<b>⚠ WARNING</b>	<b>⚠ WARNING</b>
<b>Improper use of the unit can result in serious or even fatal injuries!</b>  These operating instructions: > must have been read completely and understood before beginning any work with or at the pump-motor unit, > must be strictly observed, > must be available at the operating location of the pump-motor unit.	<b>Improper use of the unit can result in serious or even fatal injuries!</b>  Only operate the pump-motor unit  > for the purposes indicated under „Intended Use“! page 6! > with the fluids indicated under „Intended Use“! page 6! > with the values indicated under „Technical Data“!, page 8!	<b>Improper use of the unit can result in serious or even fatal injuries!</b>  Transport and handling as well as assembly and disassembly of the unit may be carried out by trained and responsible personnel only!

	<b>⚠ WARNING</b>
<p><b>When working on the unit, there is a danger of injury, e.g. in the form of cuts/ cutting off, crushing and burns!</b></p> <p>During transport/handling as well as assembly and disassembly always wear personal protective equipment (safety helmet, protective gloves, safety boots)!</p>	

	<b>⚠ WARNING</b>
<p><b>Hair and clothing can be pulled into the unit or caught and wound up moving parts!</b></p> <p>Do not wear long, loose hair or wide, loose clothes! Use a hair net!</p>	

	<b>⚠ DANGER</b>
<p><b>Electrical danger!</b></p> <p>Before beginning work on the unit or system, the following measures must be carried out:</p> <ul style="list-style-type: none"> <li>&gt; Deenergize.</li> <li>&gt; Secure against being switched on again.</li> <li>&gt; Determine whether deenergized.</li> <li>&gt; Ground and short-circuit.</li> <li>&gt; Cover or block off adjacent energized parts.</li> </ul>	



	<b>⚠ DANGER</b>
	<p><b>Electrical danger!</b></p> <p>Work on electrical installations may be carried out by trained and authorized electricians only!</p>



 	<b>⚠ WARNING</b>
<p><b>Danger due to gauge pressure and vacuum! Danger due to escaping fluid!</b></p> <ul style="list-style-type: none"> <li>&gt; Before beginning work on the unit or system: Interrupt supply of operating liquid.</li> <li>&gt; Bleed lines and vacuum pump/compressor (depressurize).</li> </ul>	

	<b>⚠ CAUTION</b>
<p><b>Danger of unit tipping over!</b></p> <ul style="list-style-type: none"> <li>&gt; Secure the pump-motor unit on the installation surface before putting into operation!</li> </ul>	

	<b>⚠ WARNING</b>
<p><b>Hazard:</b> Long, loose hair can be drawn into external fan through fan guard grate, even with fan guard mounted!</p> <p><b>Protective measures:</b> Wear hair net!</p>	

	<b>⚠ WARNING</b>
<p><b>Danger from rotating external fan of unit!</b></p> <p>Only operate the unit with the fan guard mounted!</p>	

 	<b>⚠ WARNING</b>
<p><b>Danger from rotating external fan of unit!</b></p> <p>Only operate the unit with the fan guard mounted!</p> <p>It is prohibited to remove the fan guard!</p>	

  	<b>⚠ WARNING</b>
<p><b>Danger due to gauge pressure and vacuum!</b></p> <p><b>Danger due to escaping fluid!</b></p> <p><b>Danger from rotating external fan of unit!</b></p> <p>Only operate the unit with the pipes/hoses connected to the intake and discharge connection, as well as to the operating-liquid port!</p>	

	<b>⚠ WARNING</b>
<p><b>Danger in the form of cuts or cutting off extremities on the impeller of the pump-motor unit!</b></p> <ul style="list-style-type: none"> <li>&gt; Do not reach into the unit through open connections!</li> <li>&gt; Do not insert objects into the unit through the openings!</li> </ul>	

	<b>⚠ WARNING</b>
<p><b>Danger due to gauge pressure and vacuum!</b></p> <ul style="list-style-type: none"> <li>&gt; Check the connections of the pipe/hose connections for leaks!</li> </ul>	

	<b>⚠ WARNING</b>
<p><b>Danger due to gauge pressure and vacuum! Danger due to escaping fluid!</b> Check the connections of the pipe/hose connections for leaks!</p>	

	<b>⚠ WARNING</b>
<p><b>Danger of burns and scalding from hot surfaces of the pumpmotor unit and from hot fluids!</b></p> <ul style="list-style-type: none"> <li>&gt; Do not touch during operation!</li> <li>&gt; Allow to cool after shut-down!</li> </ul>	

	<b>⚠ WARNING</b>
<p><b>Danger in the form of cuts or cutting off extremities on the impeller of the pump-motor unit!</b></p> <ul style="list-style-type: none"> <li>&gt; Do not reach into the unit through open connections!</li> <li>&gt; Do not insert objects into the unit through the openings!</li> </ul>	

	<b>⚠ WARNING</b>
<p><b>Danger zone: Hot surface.</b></p> <p><b>Hazard:</b> Burns/scalding possible.</p> <p><b>Protective measures:</b> Do not touch! Wear protective gloves!</p>	

## 2 Intended Use

### These operating instructions

- > apply to liquid-ring vacuum pumps/compressors of the LR series, types LR 060, LR 061
- > contains instructions bearing on transport and handling, installation, commissioning, operation, shut-down, storage, servicing and disposal of the LR
- > must be completely read and understood by all operating and servicing personnel before beginning to work with or on the LR,
- > must be strictly observed,
- > must be available at the site of operation of the LR.

### About the operating and servicing personnel of the LR:

- > These persons must be trained and authorized for the work to be carried out.
- > Work on electrical installations may be carried out by trained and authorized electricians only.

## 3 Intended Use

### The LR

- > are pump-motor units for generating vacuum or gauge pressure
- > are used to extract, transport and compress the following
- > all dry and humid gases, which are not explosive or flammable
- > preferably air or air/vapor mixtures

In case of corrosive or toxic gases/vapors contact service.

- > are designed for operation with the following operating liquids:
  - Water with a pH of 6 to 9, free of solid materials (such as sand)., If the pH values or operating liquids differ, it is necessary to contact service.
- > are intended for industrial applications, are designed for continuous operation.

When operating the LR the limits listed in Chapter 4, „Technical Data“, Pg. 9 ff. must always be complied with.

### Foreseeable Misuse

It is prohibited

- > to use the LR in applications other than industrial applications unless the necessary protection is provided on the system, e.g. guards suitable for children's fingers,
- > to use the device in rooms in which explosive gases can occur if the LR is not expressly intended for this purpose;
- > to extract, to deliver and to compress explosive, flammable, corrosive or toxic fluids unless the L-BV7 is specifically designed for this purpose,
- > to operate the LR with values other than those specified in Chapter 4, „Technical Data“, Pg. 9 ff.

Any unauthorized modifications of the LR06 are prohibited for safety reasons. Any maintenance and repair work, such as replacing worn or defective components, may only be carried out by companies authorized by the manufacturer (please contact service).



## 4 Technical Data

### 4.1 Mechanical data

#### Dimensions

#### LR 060-H06 / LR 061-H16

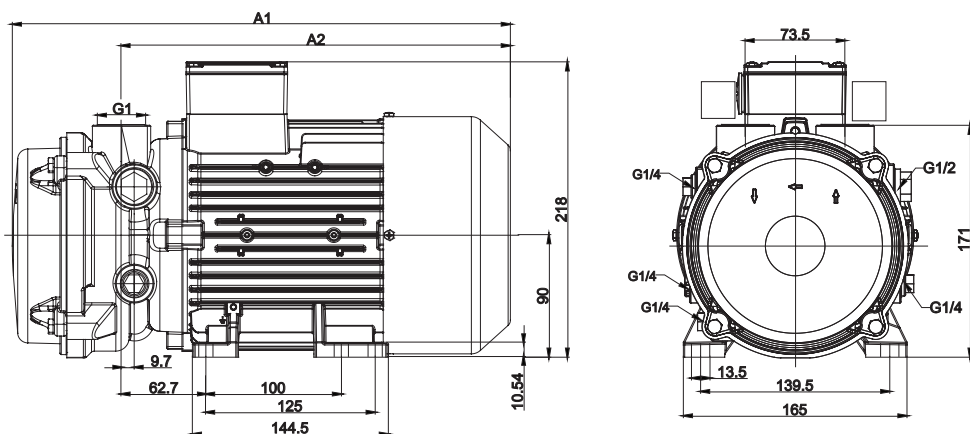

Typ	A1	A2
LR 060-H16	368,4	287,9
LR 061-H06	386,7	287,9

#### Spare part list LR 060 - H06 / LR 0161 - H16

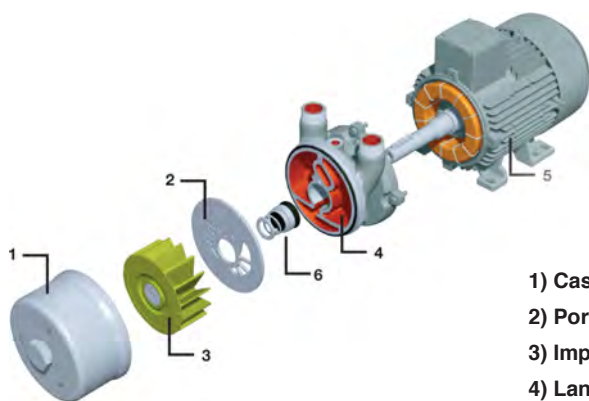

- |                           |                                     |
|---------------------------|-------------------------------------|
| <b>1) Casing</b>          | <b>Material:</b><br>Stainless steel |
| <b>2) Port plate</b>      | Stainless steel                     |
| <b>3) Impeller</b>        | Bronze                              |
| <b>4) Lantern</b>         | Cast iron with teflon coating       |
| <b>5) Motor</b>           | IE1 motor                           |
| <b>6) Mechanical seal</b> | Pot lead                            |

The recommended replacement interval of the mechanical seal is every 30 months.

**Minimum distances for heat dissipation**

Type	Minimum distance from fan guard to adjacent surface	
	(mm)	(inches)
LR 060-H16	34	1,34
LR 061-H06	34	1,34

**4.2 Operating conditions**

**Temperatures**

Temperature of pumped gases/vapors:	max. +80 °C [max. +176 °F] At higher fluid temperatures, measures must be taken on the system to prevent burns, e.g. mount separating safety device (cover).
Operating liquid temperature:	max. +80 °C [max. +176 °F] min. +5 °C [min. +41 °F] Nominal value: +15 °C +59 °F
Ambient temperature:	max. +40 °C [+104 °F] min. +5 °C [+41 °F]

**Max. discharge pressure p2 max during compressor operation (at inlet pressure p1 = 1 bar abs. [14.5 psia]):**

**Pressures**

Min. inlet pressure:	Dependent on the operating liquid temperature (see Fig. 2, Pg. 10) When this temperature is dropped below, the hose of the liquid separator (accessory) must be connected to the connection for cavitation protection (Pg. 17).
Max. discharge pressure during vacuum-pump operation:	1,1 bar abs. [16,0 psia]
Max. permissible pressure in pump-motor unit:	8 bar abs. [116 psia] If higher pressures can occur in the system, then corresponding protective devices must be provided.

Type	p2 max			
	[bar abs.]		[psia]	
	at 50 Hz:	at 60 Hz:	at 50 Hz:	at 60 Hz:
LR 060-H16	2	2	29,0	29,0
LR 061-H06	2	2	29,0	29,0

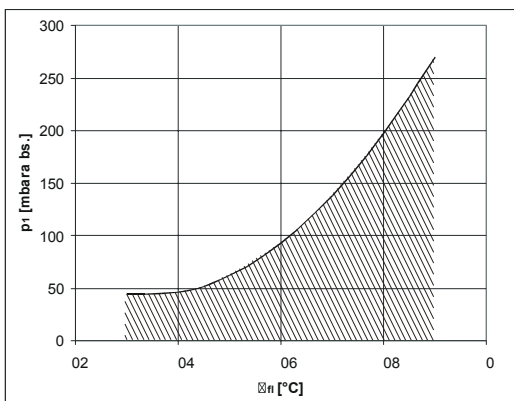

**Obr. 2: Minimum inlet pressure/cavitation limit**

t<sub>li</sub> [°C, °F] = Temperature of operating liquid  
p<sub>1</sub> [mbara abs., psia] = Inlet pressure abs.

The minimum permissible inlet pressure of the pump-motor unit is dependent on the temperature of the operating liquid. During operation without cavitation protection, the minimum inlet pressure must be set above the shaded area.

**Nominal operating-liquid flow rate**

(with dry air extraction and with water at 15°C [59 °F] as operating liquid)

Type	Flow rate			
	[m³/h]		[ft³/h]	
	at 50 Hz:	at 60 Hz:	at 50 Hz:	at 60 Hz:
LR 060-H16	0,20	0,20	7,06	7,06
LR 061-H06	0,23	0,23	8,12	8,12

**Operating-liquid filling amount for priming**

Type	Filling amount		
	[l]	[gal (US)]	[gal (UK)]
LR 060-H16	0,40	0,106	0,088
LR 061-H06	0,55	0,145	0,121

**Water requirement (L/min) / Inlet pressure P**

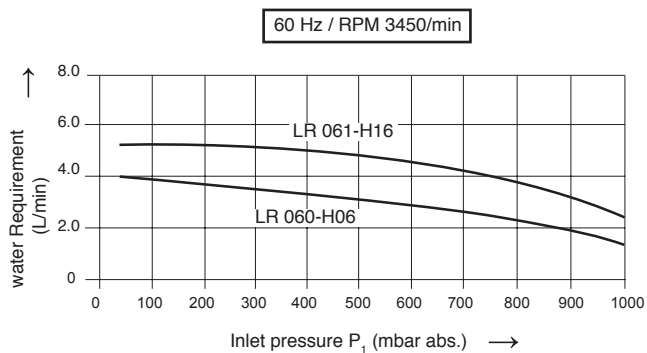
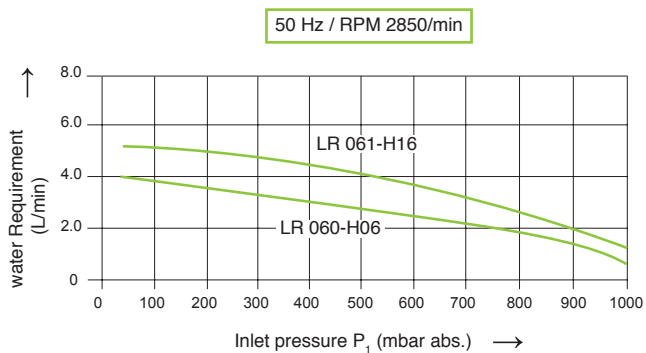

## 5 Description of Vacuum Pump/Compressor

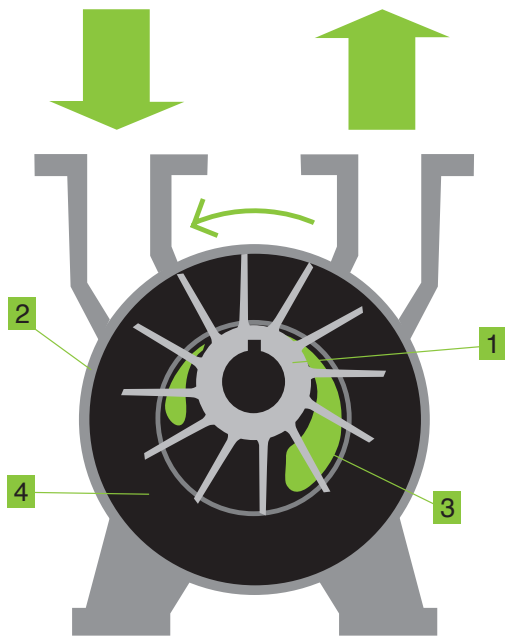

Fig. 3:

### 5.1 Design and principle

Rotor with fixed blades (1) is rotating in the stator (2), in which is situated eccentrically. Water ring is created from the service liquid (3) by the centrifugal force. The vacuum is formed and the pressure is changed in the compression chambers (4) between the blades and water ring. During the operation, the pump has to be supplied by adequate quantity of service liquid to achieve desired performance. Service liquid is also very useful for cooling of the liquid ring vacuum pump and for receiving possible contamination of sucked gas.

### 5.2 Operating method

When the impeller turns, the operating liquid is put into motion and accelerated. This forms a liquid ring that also rotates. Due to centrifugal force, this ring is arranged concentrically to the housing and eccentrically to the impeller.

During a complete rotation of the impeller, the following occurs:

- > The impeller cells are completely filled with operating liquid at the upper vertex.
- > During the first half rotation, the liquid ring lifts off the impeller hub. The space in the cells increases so that the pumped gases/vapors are sucked in through the inlet port.
- > The space in the cells is largest at the lower vertex, as these are virtually free of operating liquid.
- > During the second half rotation, the liquid ring approaches the hub again. The space in the cells decreases so that the pumped gases/vapors are compressed and pushed out through the discharge port

### 5.3 Operating modes

The pump-motor unit can function in several different operating modes. These differ in how the pump-motor unit is supplied with operating liquid:

> Self-priming operation

> Operation with operating-liquid feed:

- Non-automatic operation
- Automatic operation

#### 5.3.1 Self-priming operation

In this operating mode the pump-motor unit automatically sucks in the operating liquid. The operating-liquid flow rate is automatically adjusted.

See Fig. 8, Pg. 20.

#### 5.3.2 Operation with operating-liquid feed

In this operating mode the pump-motor unit DOES NOT automatically suck in the operating liquid.

A certain volume flow („nominal operatingliquid flow rate“) or pre-pressure must be set for the operating liquid.

**Here the following additional distinctions are made:**

##### Non-automatic operation

In this case the operating liquid feed is switched on and off manually with a stop valve.

See Fig. 11, Pg. 22.

##### Automatic operation



In this case the operating liquid feed is switched on and off by a solenoid valve. The solenoid valve is dependent on the motor operating mode:



- . Motor/pump-motor unit switched on: Valve open.
- . Motor/pump-motor unit switched off: Valve closed.

See Fig. 12, Pg. 22.



NOTICE	
	<p>The following is dependent on the operating mode:</p> <ul style="list-style-type: none"> <li>&gt; when and how the pumpmotor unit must be filled with operating liquid the first time,</li> <li>&gt; how the pump-motor unit is put into operation.</li> </ul> <p>The specifications for this are contained in Chapter 7, „Installation“, Pg. 15ff., and Chapter 8, „Commissioning“, Pg. 19ff.</p>

## 6 Transport and Handling

 	<b>⚠ WARNING</b>
	<p><b>Danger from tipping or falling loads!</b></p> <p>Prior to transport and handling make sure that all components are securely assembled and secure or remove all components the fasteners of which have been loosened!</p>

  	<b>⚠ CAUTION</b>
	<p><b>Tipping or falling can lead to crushing, broken bones etc.! Sharp edges can cause cuts!</b></p> <p>Wear personal safety equipment (protective helmet, protective gloves, safety shoes) during transport!</p>

	<b>⚠ WARNING</b>
	<p><b>Danger from lifting heavy loads!</b> Manual handling of the unit is only permitted within the following limits:</p> <ul style="list-style-type: none"> <li>. max. 30 kg [max. 66 lbs] for men</li> <li>. max. 10 kg [max. 22 lbs] for women</li> <li>. max. 5 kg [max. 11 lbs] for pregnant women</li> </ul> <p>For weights above the given values use suitable lifting appliances and handling equipment!</p>

 	<b>⚠ WARNING</b>
	<p><b>Danger from tipping or falling loads!</b></p> <p>When transporting with lifting equipment, observe the following basic rules:</p> <ul style="list-style-type: none"> <li>. The lifting capacity of lifting equipment and lifting gear must be at least equal to the unit's weight.</li> <li>. The pump-motor unit must be secured so that it cannot tip or fall.</li> <li>. Do not stand or walk under suspended loads!</li> </ul>

### Packing:

On delivery the pump-motor unit is bolted to a pallet and covered with a cardboard box. To unpack, remove the cardboard box and unscrew the securing bolts on the feet of the pump-motor unit.

Fig. 4



Transport and handling by means of a crane and strap belts is advisable.

Attach the strap belts as shown in Fig. 4, Pg. 14:

- Use two strap belts, of which one is routed under the vacuum pump/compressor housing, and one under the fan guard.
- The strap belts should be seated securely in the undercuts so that the unit cannot slip out.
- The belts must be sufficiently long (spread angle smaller than 90°).
- Make sure that no damage is caused to any attached fittings.

	<b>⚠ WARNING</b>
	<p><b>Danger from tipping loads!</b></p> <p>Be sure to observe the routing of the strap belts as shown in Fig. 4, S. 14, even if the motor is provided with attachment points such as transport eyes or eye bolts.</p> <p>These are solely designed for the separate transport of the motor, however not for the different weight distribution that results for the mounted vacuum pump/mounted compressor, so that the unit could tip!</p>

## 7 Installation

### 7.1 Installation

	<b>⚠ CAUTION</b>
	<p><b>Danger of crushing from unit tipping over!</b>                  In the unmounted state, the unit can easily tip due to its weight distribution!                  Wear gloves and safety shoes!                  Handle the unit with the appropriate care!</p>

	<b>⚠ CAUTION</b>
	<p><b>Danger of injuries from flying parts!</b>                  Select installation so that parts that are thrown out through the grate if the external fan breaks cannot hit persons!</p>

	<b>⚠ CAUTION</b>
	<p><b>Danger of damage to the pump-motor unit due to overheating!</b>                  When installing the unit, make sure that heat dissipation and cooling are not obstructed. The minimum distances specified in Chapter 4.1, „Mechanical data“, Section „Minimum distances for heat dissipation“, Pg. 10 must be complied with. Discharge air of other units may not be directly sucked in again!</p>

	<b>⚠ WARNING</b>
	<p><b>Electrical danger!</b>                  The pump-motor unit must be installed so that the electrical device cannot be damaged by external influences!                  In particular, the feed pipes must be securely routed, e.g. in cable ducts or in the floor.</p>

	<b>⚠ CAUTION</b>
	<p><b>Danger of tripping and falling!</b>                  Make sure the unit does not present a danger of tripping!</p>

For the space requirement and arrangement of the holes for installing and securing the pumpmotor unit, please see Fig. 1, Pg. 10.

For minimum clearances for heat dissipation and cooling, see Chapter 4.1, „Mechanical data“, Section „Minimum distances for heat dissipation“, Pg. 10.

The pump-motor unit must be installed as follows:

- . on level surfaces,
- . with shaft in horizontal position
- . on stationary (fixed) surfaces or structures,
- . at a maximum height of 1000 m [3280 ft] above sea level.

Observe the following when installing the pump-motor unit:

- . The load bearing capacity of the base plate or the foundation must be designed for at least the weight of the unit.
- . The vibration behavior at the operating location must be taken into account.

The total vibrations of the unit are dependent on the following factors:

- the characteristic vibrations of the unit,
- the alignment and installation,
- the condition (vibration behavior) of the load-bearing surface,
- the influences by vibrations of other parts and system components (external vibrations).

The maximum permissible value for vibrations is  $v_{eff} = 4.5 \text{ mm/s}$ . To ensure proper operation and a long service life of the unit, this value may not be exceeded. Generally, this value can be adhered to without a special foundation or a special base plate. The points on the unit for measuring the vibration speed are shown in Fig. 5, Pg. 15.

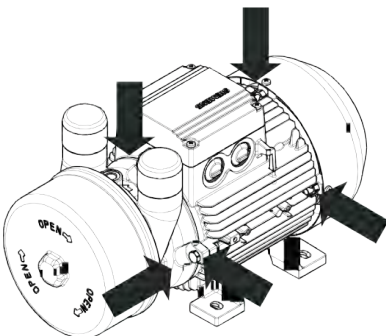

Fig. 5: Points for measuring the vibration speed

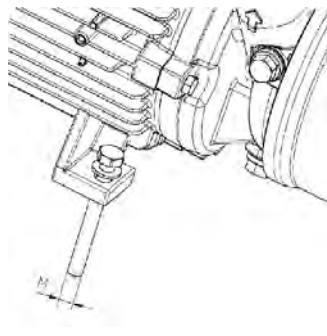

Fig. 6: Securing elements for bolting feet to supporting surface

Bolt the feet of the unit to the supporting surface with suitable securing elements, as shown in Fig. 6, Pg. 15.

LR 060-H16

LR 061-H06: M = 4 x M8-6.8

## 7.2 Electrical connection (motor)



The electrical connection must be carried out as follows:

- according to the applicable national and local laws and regulations,
- according to the applicable system-dependent prescriptions and requirements,
- according to the applicable regulations of the utility company.

	<b>⚠ DANGER</b>
	<p><b>Electrical danger!</b></p> <p>Malpractice can result in severe injuries and material damage!</p>

	<b>⚠ DANGER</b>
	<p><b>Electrical danger!</b></p> <p>The electrical connection may be carried out by trained and authorized electricians only!</p>

	<b>⚠ DANGER</b>
	<p><b>Electrical danger!</b></p> <p>Before beginning work on the unit or system, the following measures must be carried out:</p> <ul style="list-style-type: none"> <li>. Deenergize</li> <li>. Secure against being switched on again.</li> <li>. Determine whether deenergized.</li> <li>. Ground and short-circuit.</li> <li>. Cover or block off adjacent energized parts.</li> </ul>

 	<b>⚠ WARNING</b>
	<p><b>Danger due to gauge pressure and vacuum!</b>  <b>Danger due to escaping fluid!</b></p> <p>Before beginning work on the unit or system:</p> <ul style="list-style-type: none"> <li>. Interrupt supply of operating liquid.</li> <li>. Bleed lines and vacuum pump/compressor (depressurize).</li> </ul>

	<b>⚠ CAUTION</b>
	<p>Incorrect connection of the motor can lead to serious damage to the unit!</p>

	<b>⚠ WARNING</b>
	<p><b>Electrical danger!</b></p> <p>Clearance between bare live parts and between bare live parts and ground: at least 5.5 mm [0.217"] (at a nominal voltage of <math>V_n \leq 690V</math>)</p> <p>Make sure there are no protruding pieces of wire!</p>

For motor overload protection:

- > Use motor circuit breakers.
- > Set the motor circuit breakers to the nominal current specified on the rating plate.

For supply by converter:

- > High-frequency current and voltage harmonics in the motor supply cables can lead to emitted electromagnetic interference.
- > Use shielded supply cables, whereby the shield must be installed on both sides

	<b>⚠ WARNING</b>
	<p><b>Electrical danger!</b></p> <p>The terminal box must be free from</p> <ul style="list-style-type: none"> <li>- foreign bodies</li> <li>- dirt</li> <li>- a humidity</li> </ul> <p>Terminal box cover and cable entries must be tightly closed so as to make them dustproof and waterproof. Check for tightness at regular intervals.</p>

Observe the motor rating plate. It is imperative that the operating conditions correspond to the data given on the rating plate!

Deviations permissible without reduction in performance:

- > ±5 % voltage deviation
- > ±2 % frequency deviation

Make the connection in accordance with the circuit diagram in the terminal box. Connect the protective conductor.

- > Use suitable cable lugs when doing so
- > The electrical connection must be permanently safe



### 7.3 Connecting pipes/hoses (vacuum pump/compressor)

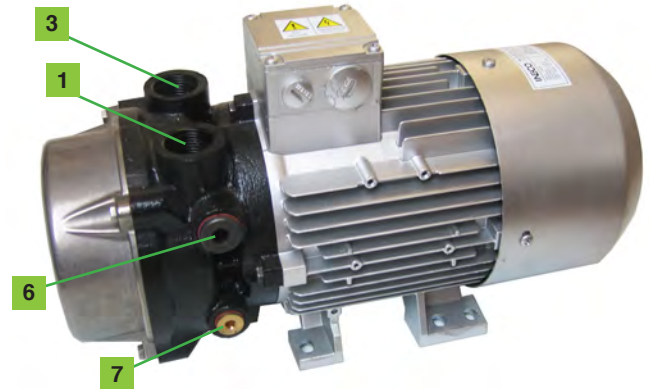

Obr. 7: Pipe/hose connection of vacuum pump/compressor

- 1) OUTPUT of air and suction liquid
- 2) Connection of operating liquid (water temperature max. 35 °C, optimal temperature is 15°C)
- 3) INPUT of suction vacuum
- 4) Connection of vacuum safety valve
- 5) Discharge (threaded connector)
- 6) Connection of manometer
- 7) Cavitation protection (noise reduction)

To prevent foreign bodies from entering the unit, all connections are sealed off when delivered. Do not remove the sealing plugs until immediately before connecting the pipes/hoses.

For the arrangement of the pipe/hose connection, see Fig. 7, Pg. 17. The pumped gases/vapors are sucked in via the inlet connection (see Chapter 7.3.1, Pg. 18) and discharged via the discharge connection ((see Chapter 7.3.2, Pg. 18). For operation the unit must be continuously supplied with operating liquid. This is fed in via the operating-liquid port (Chapter 7.3.3, Pg. 26) and discharged together with the pumped gases/vapors through the discharge connection.

#### Fill with operating liquid:

When and how the pump-motor unit must be filled with operating liquid the first time is dependent on the operating mode:

- . For self-priming operation: During installation.
- . For operation with operating-liquid feed: After completing installation

For self-priming operation you now pour operating liquid into the working space of the pump-motor unit before you connect the pipes/hoses to the unit. To do this, pour operating liquid into the open inlet connection, discharge connection or operating-liquid port. For proper filling quantities, see Chapter 4.3, „Operating conditions“, Section „Operating-liquid filling amount for priming“, Pg. 11. Then attach the pipes/hoses to the unit as described in the following.

	⚠ WARNING
	<p><b>Danger due to gauge pressure and vacuum!</b>  <b>Danger due to escaping fluid!</b></p> <ul style="list-style-type: none"> <li>. During operation, connected pipes and vessels are pressurized or vacuumized!</li> <li>. Make sure that all connections are sufficiently tight! Use only pipes and vessels of sufficient strength!</li> </ul>

NOTICE	
Attach pipes/hoses free of mechanical tensions. Support the weight of the pipes/hoses.	
	⚠ CAUTION
If the unit is run dry, the mechanical seal will be destroyed in a matter of seconds! DO NOT switch on as long as the unit is not filled with operating liquid!	

### 7.3.1 Inlet connection

The inlet connection (Fig. 7, Pg. 17) is marked with an arrow pointing downward (↓). Connect the inlet pipe here. The pumped gases/vapors are sucked in via this.

	<b>⚠ CAUTION</b>
	The tightening torque for pipe connections on intake and discharge connections may not exceed 100 Nm [73.8 ft lbs]!

### 7.3.2 Discharge connection

The discharge connection (Fig. 7, Pg. 17) is marked with an arrow pointing upward (↑). Connect the discharge pipe here. Both the pumped gases/vapors and the operating liquid are discharged via this pipe.

	<b>⚠ CAUTION</b>
	The tightening torque for pipe connections on intake and discharge connections may not exceed 100 Nm [73.8 ft lbs]!

### 7.3.3 Operating-liquid port

The operating-liquid port (Fig. 7, Pg. 17) is located between the discharge and inlet connection. Connect the feed pipe for the operating liquid here.

	<b>NOTICE</b>
	For operating liquid with impurities: > Install a filter, screen or separator in the supply line if necessary.

	<b>NOTICE</b>
	In case of operating liquid with a high lime content: <ul style="list-style-type: none"> <li>. Soften operating liquid OR</li> <li>. Decalcify pump-motor unit regularly (see Chapter 11.1, „Maintenance“, Pg. 26).</li> </ul>

	<b>NOTICE</b>
	To prevent installation residues (e.g. welding spatter) from entering the unit, a start-up screen should be installed in the inlet pipe for the first 100 operating hours.

## 8 Commissioning

⚠ <b>WARNING</b>	
	<p><b>Danger due to gauge pressure and vacuum!</b>  <b>Danger due to escaping fluid!</b>  <b>Danger due to rotating parts!</b></p> <p>The pump-motor unit may only be put into operation when the following conditions are met:</p> <ul style="list-style-type: none"> <li>- Fan guard and vacuum pump/compressor housing are mounted.</li> <li>- The lines to the discharge connection, inlet connection and operating-liquid port are attached.</li> <li>- The lines and connections have been tested for strength and leaks.</li> </ul>

⚠ <b>CAUTION</b>	
	<p>If the unit is run dry, the mechanical seal will be destroyed in a matter of seconds!  <b>DO NOT</b> switch on as long as the unit is not filled with operating liquid!</p>

### 8.1 Preparation and start-up

⚠ <b>CAUTION</b>	
	<p>If the pumped gases/vapors discharged on the pressure side are passed on, then it must be ensured that the maximum discharge pressure of 1.1 bar abs. [16.0 psia] is not exceeded!</p>

NOTICE	
	<p>Maximum permissible quantity of water entrained via the inlet connection:          See Fig. 13, Pg. 22</p>

If a shut-off device is installed in the discharge pipe: Make sure that the unit **CANNOT** be operated with the shut-off device closed.

#### Fill with operating liquid:

When and how the pump-motor unit must be filled with operating liquid the first time is dependent on the operating mode:

> For self-priming operation:  
 During installation.

> For operation with operating-liquid feed:  
 After completing installation.

**For operation with operating-liquid feed, you now fill the working area of the unit with operating liquid. To do this, open the respective stop valve for approx. 20 sec.:**

> For non-automatic operation:  
 Stop valve (Fig. 11, Pg. 22, item 4).

> For automatic operation: Stop valve in the bypass pipe (Fig. 12, Pg. 22, item 4a).

Then proceed with commissioning as described in the following.

**Check connections of the pipes/hoses for leaks.**



**Check direction of rotation:**

- > The direction of flow of the pumped gases/vapors is marked with arrows on the intake and discharge connection.
- > The intended direction of shaft rotation is marked with an arrow on the motor mounting adapter between the intake and discharge connection, as well as with an arrow on the fan guard.
- > The pump-motor unit may not be allowed to run dry! Have you filled it with operating liquid beforehand (during or after installation)?  
provozního režimu agregátu:

See sections „Fill with operating liquid“ ,Pg. 17 a Pg. 18.

- > Briefly switch on pump-motor unit.
- > Compare the actual direction of rotation of the external fan with the intended direction of shaft rotation as indicated with the arrows.
- > Switch off pump-motor unit again.
- > If necessary, reverse the direction of rotation of the motor.

	<b>⚠ DANGER</b>
	<p><b>Electrical danger!</b> Before beginning work on the unit or system, the following measures must be carried out:</p> <ul style="list-style-type: none"> <li>- Deenergize.</li> <li>- Secure against being switched on again.</li> <li>- Determine whether deenergized.</li> <li>- Ground and short-circuit.</li> <li>- Cover or block off adjacent energized parts.</li> </ul>

	<b>⚠ DANGER</b>
	<p><b>Electrical danger!</b> The electrical connection may be carried out by trained and authorized electricians only!</p>
 	<b>⚠ WARNING</b>
<p><b>Danger due to gauge pressure and vacuum!</b> <b>Danger due to escaping fluid!</b> Before beginning work on the unit or system:</p> <ul style="list-style-type: none"> <li>. Interrupt supply of operating liquid.</li> <li>. Bleed lines and vacuum pump/compressor (depressurize).</li> </ul>	

**8.2 Self-priming operation**

See Fig. 8, Pg. 20.

Here the following must be watched:

- > The pump-motor unit must be pre-throttled on the inlet side. This means a vacuum of at least 900 mbar abs. [13.1 psia] must be present in the inlet pipe (Item B) at switchon.
- > During switch-on, the liquid level in the feed pipe (Item A) and in the reservoir (Item C) respectively must be at the same level as the center of the unit shaft (Item 1).
- > During operation the liquid level in the reservoir (Item C) may not drop below approx. 1 m [3.28 ft] below the center of the unit shaft (Item 1).

Starting the pump-motor unit:

- > Switch on the unit.
- > The operating liquid is sucked in.

- A Feed pipe for operating liquid
- B Inlet pipe
- C Reservoir for operating liquid

- 1 Required liquid level when switching on
- 2 Min. liquid level during operation

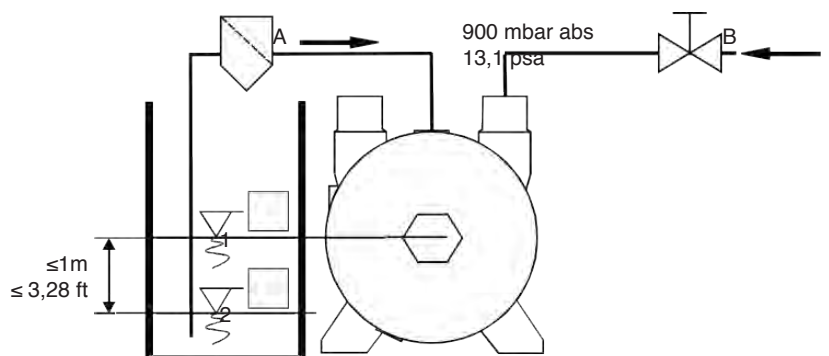

**Fig. 8: Self-priming operation**

### 8.3 Operation with operating-liquid feed

See Fig. 9, Pg.21; and Fig. 10, Pg. 21, as well as Fig. 11, Pg. 22 and Fig. 12, Pg. 22.

**Proceed as follows here:**

**Metoda A:**

1) Set pre-pressure of operating liquid (Fig. 9, Pg. 21):

> Set a pre-pressure  $p_A$  in the feed pipe for the operating liquid (Item A) around approx. 1 bar [14.5 psi] above the inlet pressure  $p_B$  in the inlet pipe (Item B).

2) Start up the unit:

For non-automatic operation (Fig. 11, Pg. 22):

- > Open the stop valve (Item 4) manually. The operating liquid is fed in.
- > Switch on the unit.

For automatic operation (Fig. 12, Pg. 22):

- > Switch on the unit.
- > The solenoid valve (Item 4) opens and the operating liquid is fed in.

**Metoda B:**

1) Start up the unit:

For non-automatic operation (Fig. 11, Pg. 22):

- > Open the stop valve (Item 4) manually. The operating liquid is fed in.
- > Switch on the unit.

For automatic operation (Fig. 12, Pg. 22):

- > Switch on the unit.
- > The solenoid valve (Item 4) opens and the operating liquid is fed in.

2) Check the operating-liquid flow rate:

- > with the flow meter (Fig. 11, Pg. 22, and Fig. 12, Pg. 22, Item 2) OR
- > by measuring the volume of operating liquid per unit of time that exits at the discharge connection with a graduated vessel (Fig. 10, Pg. 21)

3) Set/correct the operating-liquid flow rate:

- > via the control valve (Fig. 11, Pg. 22, and Fig. 12, Pg. 22, Item 3).
- > Nominal operating-liquid flow rate: For nominal values, see Chapter 4.3, „Operating conditions“, Section „Nominaloperating-liquid flow rate“, Pg. 11.

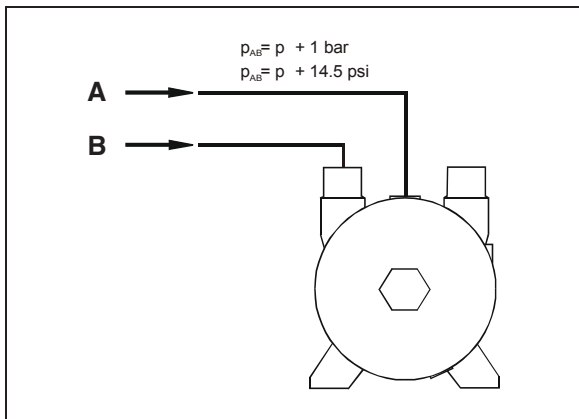

**Obr. 9: Setting the operating-liquid flow rate: Setting pre-pressure**

A Feed pipe for operating liquid  
B Inlet pipe

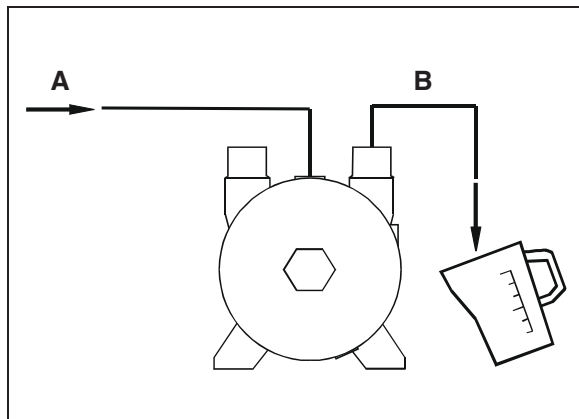

**Fig. 10: Setting the operating-liquid flow rate: Measuring the volume with a graduated vessel**

A Feed pipe for operating liquid  
B Drain pipe for operating liquid

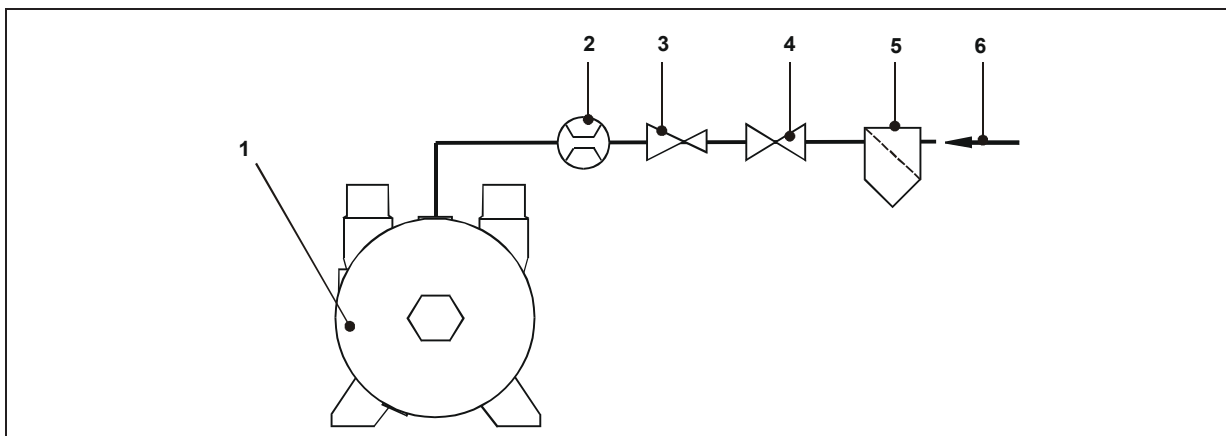

**Fig. 11: Operation with operating-liquid feed: Non-automatic operation**

- |                   |                                  |
|-------------------|----------------------------------|
| 1 Pump-motor unit | 4 Stop valve                     |
| 2 Flow meter      | 5 Filter                         |
| 3 Control valve   | 6 Feed pipe for operating liquid |

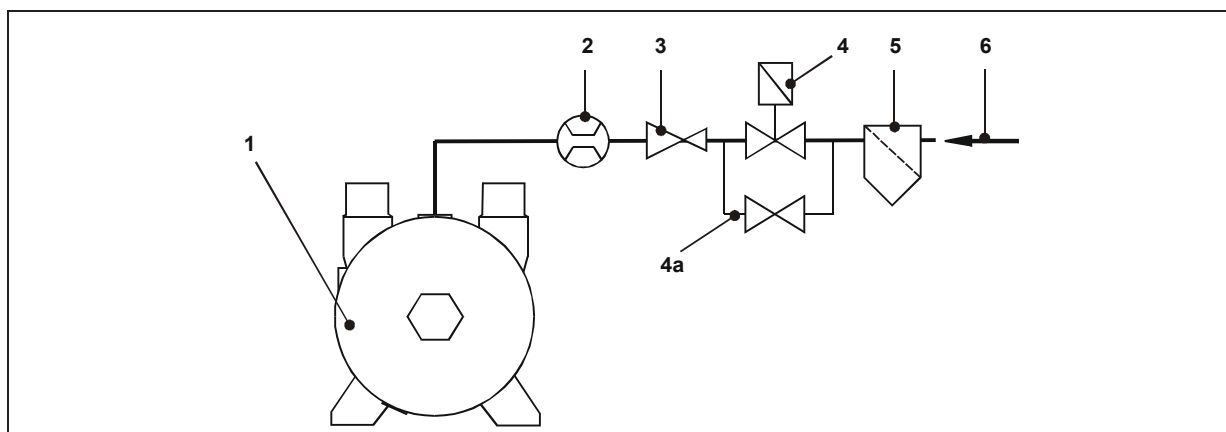

**Fig. 12: Operation with operating-liquid feed: Automatic operation**



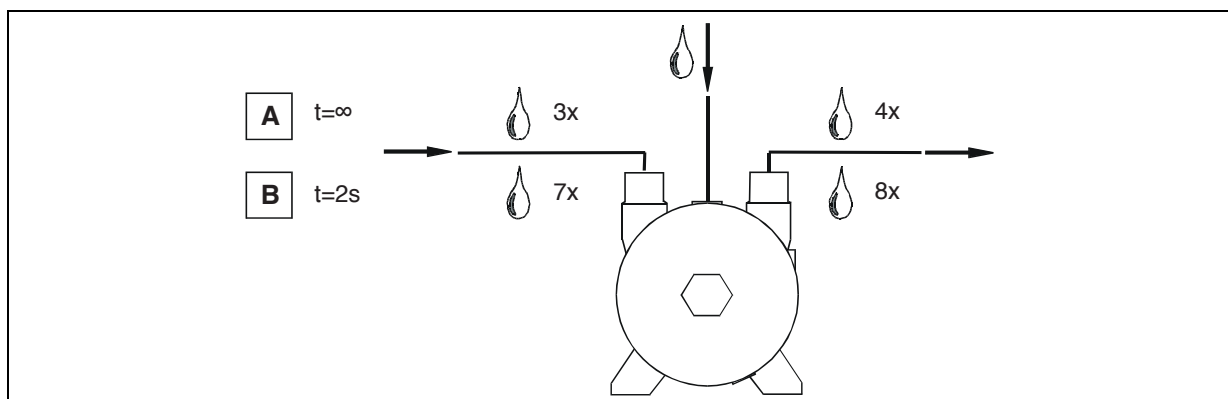

- |                                      |   |
|--------------------------------------|---|
| 1 Pump-motor unit                    | 4a Bypass with stop valve (for priming) |
| 2 Flow meter                         | 5 Filter                                |
| 3 Control valve                      | 6 Feed pipe for operating liquid        |
| 4 Solenoid valve, connected to motor |   |







**Fig. 13: Maximum permissible quantity of water entrained via the inlet connection**



- A During continuous operation: 3x quantity of operating-liquid flow rate  
 B Briefly (up to 2 sec.): 7x quantity of operating-liquid flow rate

## 9 Operation

 <b>WARNING</b>	
   	<p><b>Danger due to gauge pressure and vacuum!</b>  <b>Danger due to escaping fluid!</b>  <b>Danger due to rotating parts!</b></p> <p>The pump-motor unit may only be put into operation when the following conditions are met:</p> <ul style="list-style-type: none"> <li>- Fan guard and vacuum pump/compressor housing are mounted.</li> <li>- The lines to the discharge connection, inlet connection and operating-liquid port are attached.</li> <li>- The lines and connections have been tested for strength and leaks.</li> </ul>

 <b>CAUTION</b>	
	<p>If the unit is run dry, the mechanical seal will be destroyed in a matter of seconds! <b>DO NOT</b> switch on as long as the unit is not filled with operating liquid!</p>

 <b>WARNING</b>	
	<p><b>Danger of burns and scalding from hot surfaces of the pumpmotor unit and from hot fluids!</b></p> <ul style="list-style-type: none"> <li>&gt; Do not touch during operation!</li> <li>&gt; Allow to cool after shut-down!</li> </ul>

 <b>NOTICE</b>	
	<p>Maximum permissible quantity of water entrained via the inlet connection: See Fig. 13, Pg. 32.</p>

### 9.1 Self-priming operation

Follow the instructions contained in Chapter 8.2, „Self-priming operation“, Pg. 20 for this operating mode.

### 9.2 Operation with operating-liquid feed

#### Start-up

For non-automatic operation (Fig. 11, Pg. 22):

- Open the stop valve (Item 4) manually. The operating liquid is fed in.
- Switch on the unit.

For automatic operation (Fig. 12, Pg. 22):

- Switch on the unit.
- The solenoid valve (Item 4) opens and the operating liquid is fed in.

#### Shut down:

For non-automatic operation (Fig. 11, Pg. 22):

- Switch off the pump-motor unit.
- Close the stop valve (Item 4) manually. Feeding of the operating liquid is cut off.
- The following applies for the control valve (Item 3) for setting the operating-liquid flow rate:  
 In case of an interruption in operation, the valve setting (i.e. the valve position or the open valve cross-section) is not changed.

For automatic operation (Fig. 12, Pg. 22):

- Switch off the pump-motor unit.
- The solenoid valve (Item 4) closes, and feeding of the operating liquid is cut off.
- The following applies for the control valve (Item 3) for setting the operating-liquid flow rate:  
 In case of an interruption in operation, the valve setting (i.e. the valve position or the open valve cross-section) is not changed.

## 10 Shut-Down and Longer Standstills

### 10.1 Draining

⚠ DANGER
 <p><b>Electrical danger!</b> Before beginning work on the unit or system, the following measures must be carried out:</p> <ul style="list-style-type: none"> <li>&gt; Deenergize.</li> <li>&gt; Secure against being switched on again.</li> <li>&gt; Determine whether deenergized.</li> <li>&gt; Ground and short-circuit.</li> <li>&gt; Cover or block off adjacent energized parts.</li> </ul>

⚠ WARNING
 <p><b>Danger due to gauge pressure and vacuum!</b> <b>Danger due to escaping fluid!</b> Before beginning work on the unit or system:</p> <ul style="list-style-type: none"> <li>- Interrupt supply of operating liquid.</li> <li>- Bleed lines and vacuum pump/compressor (depressurize).</li> </ul>

- > Switch off the pump-motor unit.
- > The above safety precautions apply when working on the unit or system.
- > Provide suitable catch containers below the vacuum pump/compressor housing.
- > Open the screw plug (Fig. 7, Pg. 17, item 5).
- > Allow the liquid to drain out.
- > Close the screw plug again, tightening torque  $T_t = 2 \dots 3 \text{ Nm}$  [1.48 ... 2.21 ft lbs].

### 10.2 Preparing for longer standstill

Before a longer standstill (from approx. 4 weeks) or when there is danger of frost, proceed as follows:

- > Drain pump-motor unit as described in Chapter 10.1, „Draining“, Pg. 24.
- > Remove the pipe/hose from the intake or discharge connection.
- > Pour  $\frac{1}{2}$  l [0.132 gal (US); 0.110 gal (UK)] of preservative (rust protection oil, e.g. Mobilarma 247 form Mobil Oil) into the open intake or discharge connection
- > Close the intake and discharge connection, as well as the operating-liquid port and remount the disconnected pipes/hoses.
- > Guide a M6 or M8 bolt (depending on the type) with a sufficient shank length through the center opening into the fan guard and screw into the shaft end on the external fan side (prostudujte si Fig. 14, Pg. 24).
- > Turn the shaft by hand using the bolt.
- > Remove the M6 or M8 bolt again.
- > You have two options for the standstill: Either the pump-motor unit remains connected in the system, or the unit is removed for storage.

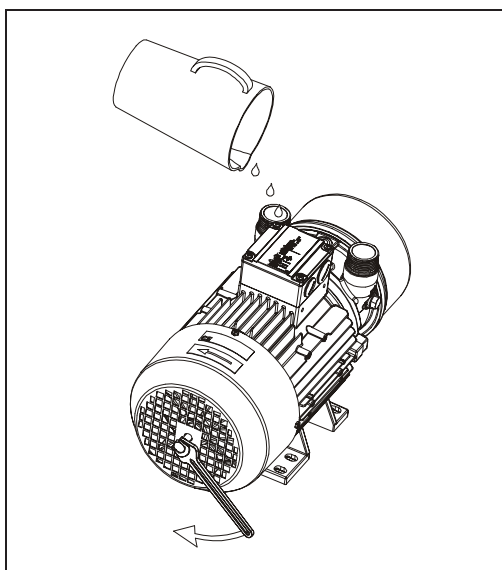

**Fig. 14: Pour in preservative and turn shaft**



### 10.3 Storage conditions

This chapter applies in the following cases:

- > new pump-motor units,
- > pump-motor unit that are already installed in a system and were prepared for a longer standstill, as described in Chapter 10.2 „Preparing for longer standstill“, Pg. 24.

To prevent standstill damage during storage, the environment must provide the following conditions:

- > dry,
- > dust-free,
- > low-vibration (effective value of vibration speed  $v_{eff} \leq 0.2 \text{ mm/s}$  [0.008"/sec]).

Take the following measures for commissioning following a longer standstill:



- > Measure the insulation resistance of the motor. In case of values  $\leq 1 \text{ k}\Omega$  per volt of nominal voltage, dry winding.
- > Drain off preservative, as described in Chapter 10.1, „Draining“, Pg. 24. Subsequent cleaning of the pump-motor unit is not required. Dispose of preservative in accordance with the manufacturer’s specifications.
- > For new pump-motor units: Install pump-motor unit as described in Chapter 7, „Installation“, Pg. 15. Commission the pump-motor unit as described in Chapter 8, „Commissioning“, Pg. 19.





For pump-motor unit that are already installed in a system:

Commission the pump-motor unit as described in Chapter 8, „Commissioning“, Pg. 19.



## 11 Servicing

	<b>⚠ DANGER</b>
	<p><b>Electrical danger!</b> Before beginning work on the unit or system, the following measures must be carried out:</p> <ul style="list-style-type: none"> <li>&gt; Deenergize.</li> <li>&gt; Secure against being switched on again.</li> <li>&gt; Determine whether deenergized.</li> <li>&gt; Ground and short-circuit.</li> <li>&gt; Cover or block off adjacent energized parts.</li> </ul>

 	<b>⚠ WARNING</b>
	<p><b>Danger from rotating external fan of unit!</b> It is prohibited to remove the fan guard!</p>

   	<b>⚠ WARNING</b>
	<p><b>Nebezpečí v důsledku přetlaku a podtlaku!</b> <b>Danger due to gauge pressure and vacuum!</b> <b>Danger due to escaping fluid!</b> <b>Danger due to rotating parts!</b></p> <p>The pump-motor unit may only be put into operation when the following conditions are met:</p> <ul style="list-style-type: none"> <li>- Fan guard and vacuum pump/compressor housing are mounted.</li> <li>- The lines to the discharge connection, inlet connection and operating-liquid port are attached.</li> <li>- The lines and connections have been tested for strength and leaks.</li> </ul>

	<b>⚠ WARNING</b>
	<p><b>Danger of burns and scalding from hot surfaces of the pumpmotor unit and from hot fluids!</b> Do not touch during operation! Allow to cool after shut-down!</p>

  	<b>⚠ WARNING</b>
	<p><b>When working on the unit, there is a danger of injury, e.g. in the form of cuts/cutting off, crushing and burns!</b></p> <p>During transport/handling as well as assembly and disassembly always wear personal protective equipment (safety helmet, protective gloves, safety boots)!</p>

## 11.1 Maintenance

### The pump-motor unit is largely maintenancefree.

However, if dirt or solid matter (e.g. sand) or lime deposits get into the unit through the operating liquid and/or the pumped gases/vapors, then it is necessary to clean the unit at regular intervals to prevent the impeller from jamming up and to avoid wearing of the impeller and the vacuum pump/compressor housing.

#### Refer to the following table:

Contamination / Problem	Remedy
Dirt collects in the motor cooling fins.	Clean the motor cooling fins at regular intervals.
Mechanical seal - leaking	The recommended replacement interval of the mechanical seal is every 30 months.
Fine-grain dirt (e.g. sand) get into the vacuum pump/compressor with the operating liquid or pumped gases/vapors.	Install a liquid separator, filter or screen in the feed pipe. OR Regularly dismantle and clean the vacuum pump/compressor housing as follows: > Shut unit down. > Drain the pump-motor unit as described in Chapter 10.1, „Draining“, Pg. 24. > Unscrew the housing with a 36 mm [3/8“] wrench (in direction of arrow shown on housing) (see Fig. 15, Pg. 27). > Remove the housing. > Dirt has collected in the housing. Rinse out the housing. > Screw on the housing again (opposite direction of arrow shown on housing) and tighten with a tightening torque of 50 Nm [36.9 ft lbs]. > When commissioning the pump-motor unit, proceed as described in Chapter 8, „Commissioning“, Pg. 19.
Impeller is jammed.	> Shut unit down. > Guide a M6 or M8 bolt (depending on the type) with a sufficient shank length through the center opening into the fan guard and screw into the shaft end on the external fan side (see Fig. 16, Pg. 27). > Free the shaft using the bolt. > Remove the bolt again.
Extremely hard water used as operating liquid Lime content > 15°dH).	Soften operating liquid. OR Decalcify the pump-motor unit at intervals of 3 months as follows (also see Fig. 16, Pg. 27): > Wear personal protective equipment (protective gloves and safety goggles), > Shut unit down. > Drain the pump-motor unit as described in Chapter 10.1, „Draining“, str. 24. > Remove pipes/hoses. > Fill the unit with decalcifying liquid through one of the connection openings. Use 10% solution of acetic acid or another commercially available decalcifying agent. > Allow the decalcifying liquid to soak for at least 30 minutes. > Turn the shaft occasionally during this time. To do this, guide a M6 or M8 bolt (depending on the type) with a sufficient shank length through the center opening into the fan guard and screw into the shaft end on the external fan side (See Fig.16, Pg. 38). > Turn the shaft using the bolt. > Remove the bolt again. > Drain the decalcifying liquid out of the unit. To do this, proceed as described in Chapter 10.1, „Draining“, Pg. 34. > Mount pipes/hoses. > When commissioning the pump-motor unit, proceed as described in Chapter 8, „Commissioning“, Pg. 28. > The decalcifying liquid can be disposed of in the sewer system.

Contamination/Problem	Remedy
Dirt gets into the air passages (fan guard, external fan, cooling fins) of the motor.	Clean the motor air passages regularly. To do so, proceed as follows: > Carry out protective measures for the use of compressed air: Wear personal protective equipment (protective gloves and safety goggles) secure surroundings. Remove objects lying around., > Blow in compressed air through the fan guard grate. > It is prohibited to remove the fan guard!

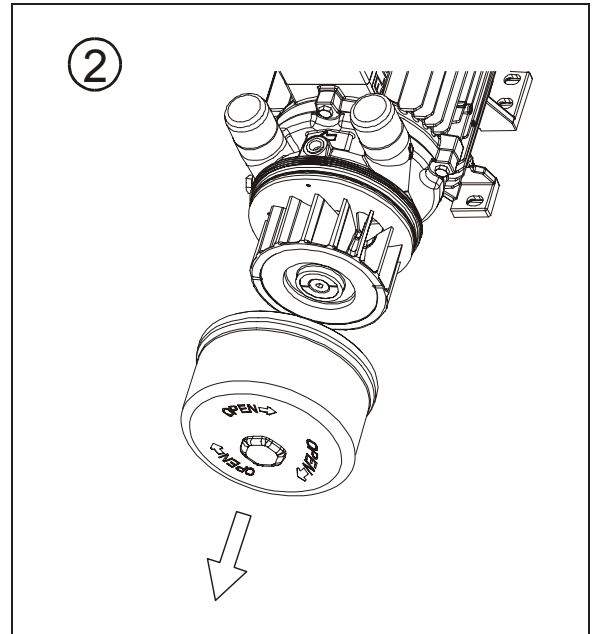
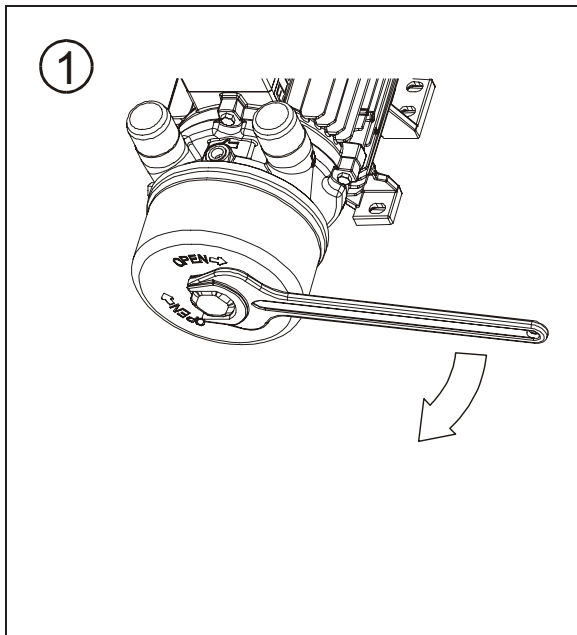

**Obr. 15: Removing vacuum pump/compressor housing**  
 Carry out with 36 mm [3/8"] open-end wrench.

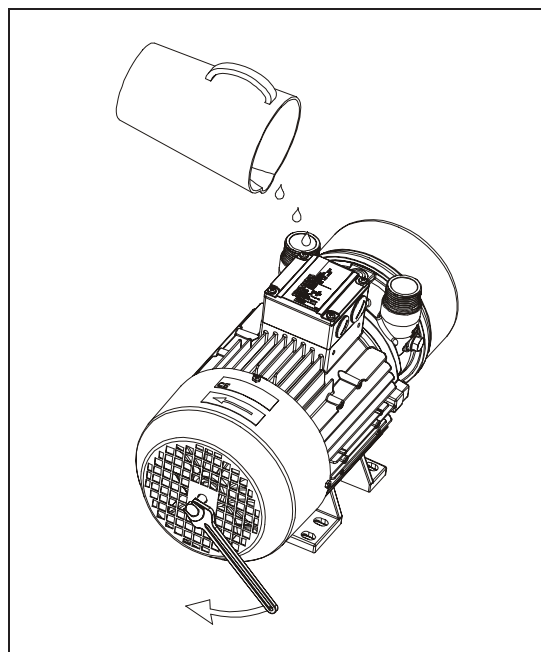

**Fig. 16: Pouring in decalcifying agent and freeing shaft by turning**

## 11.2 Repairs/troubleshooting

Fault	Cause	Remedy	Carried out by
Motor does not start, no motor noise.	At least two power supply leads interrupted.	Check fuses, terminals and cables for open circuit. Eliminate open circuit.	Electrician
Motor does not start, humming noise.	One power supply lead interrupted.	Check fuses, terminals and cables for open circuit. Eliminate open circuit.	Electrician
	Impeller is jammed.	Free shaft by turning. See Chapter 11.1, „Maintenance“, Pg. 36	Operator
		Decalcify vacuum pump/compressor. See Chapter 11.1, „Maintenance“, Pg. 26	Operator
		Drain and clean vacuum pump/compressor if necessary. See Chapter 11.1, „Maintenance“, Pg. 25,26.	Operator
		Check and correct impeller gap setting if necessary.	Service
	Impeller defective.	Replace impeller.	Service
Motor bearings defective.	Replace motor bearings.	Service	
Protective motor switch trips when motor is switched on.	Winding short-circuit.	Have winding checked	Electrician
	Motor overloaded.	Throttle operating-liquid flow rate. See Chapter 8.2, „Self-priming operation“, Pg. 20 or 8.3, „Operation with operating-liquid feed“, Pg. 21.	Operator
	Counter-pressure at discharge connection too high.	Reduce counter-pressure.	Operator
	Share of liquid also fed too high.	Reduce share of liquid also fed.	Operator
	Impeller is jammed.	See „Motor does not start, humming noise.“	Service
Power Operator consumption too high.	Lime or other deposits.	Decalcify vacuum pump/compressor. See Chapter 11.1, „Maintenance“, Pg. 26.	Operator
		Clean vacuum pump/compressor. See Chapter 11.1, „Maintenance“, Pg. 26.	Operator
Agregát nevytváří podtlak.	Není přítomná provozní kapalina.	Zajistěte správný průtok provozní kapaliny. Prostudujte si kapitulu 8.2, „Samonasávací provoz“, str. 20 nebo kapitulu 8.3, „Provoz s aktivním přívodem provozní kapaliny“, str. 21.	Obsluha
	Závažná netěsnost v systému.	Netěsnost v systému utěsněte.	Obsluha
	Nesprávný směr otáčení.	Záměnou dvou propojovacích vodičů změňte směr otáčení.	Odborný elektropersonál

Fault	Cause	Remedy	Carried out by
Unit does not generate vacuum.	Unit too small.	Use larger unit.	Operator
	Operating-liquid flow too low.	Increase operating-liquid flow rate to up to 2x the nominal flow rate. See Chapter 8.2, „Self-priming operation“, Pg. 20 or Chapter 8.3, „Operation with operating-liquid feed“, Pg. 21.	Operator
	Operating liquid too warm (nominal temperature: 15°C [59 °F]).	Cool or increase operating-liquid flow, See Chapter 8.2, „Self-priming operation“, Pg. 20 or 8.3, „Operation with operating-liquid feed“, Pg. 21.	Operator
	Erosion.	Inspect impeller. To do so, proceed as follows: <ul style="list-style-type: none"> <li>. Shut unit down.</li> <li>. Drain the pump-motor unit as described in Chapter 10.1, „Draining“, Pg. 24.</li> <li>. Unscrew the housing with a 36 mm [3/8"] wrench (in direction of arrow shown on housing) (see Fig. 15, Pg. 27).</li> <li>. Remove the housing.</li> <li>. Examine the impeller for erosion.</li> <li>. Have the impeller replaced by Service if necessary</li> <li>. Screw on the housing again (opposite direction of arrow shown on housing) and tighten with a tightening torque of 50 Nm [36.9 ft lbs].</li> <li>. When commissioning the pump-motor unit, proceed as described in Chapter 8, „Commissioning“, Pg. 19.</li> </ul>	Operator
		Replace affected components.	Service
	Slight leak in the system.	Seal leak in the system.	Operator
	Mechanical seal leaky.	Replace mechanical seal.	Service
Abnormal screeching noise.	Cavitation of vacuum pump/compressor	Connect cavitation-protection hose of liquid separator (see Chapter 13.5, „Cavitation protection“, Pg. 34) or clean cavitation-protection equipment.	Operator
	Operating-liquid flow rate too high.	Check operating-liquid flow rate and reduce if necessary. See Chapter 8.3, „Operation with operating-liquid feed“, Pg. 21.	Operator
Unit leaky.	Seals defective.	Check seals.	Service

## 11.3 Spare parts

### 11.3.1 Ordering IN-ECO spare parts

When ordering IN-ECO parts, always indicate the following:

- Type designation (LR 060-H16 or LR 061-H06) complete with all additions(as per rating plate)
- Serial number
- Part item number, 4-digit (as per parts list for exploded view, Chapter 14, „Exploded View with Parts List“, Pg. 38)

### 11.3.2 Ordering standardized parts

Commercially available standardized parts can be purchased on the open market. When doing so, observe the information in the parts list exactly, especially the design, dimensions, property class etc.

## 11.4 Service/After-sales service

Our Service is available for work (in particular the installation of spare parts, as well as maintenance and repair work), not described in these operating instructions (see front page of these operating instructions).

Observe the following when returning pumpmotor unit:

>Before shipping:





- Drain the pump-motor unit so that it is residue-free, as described in Chapter 10.1, „Draining“, Pg. 24.
- Clean the unit on the inside and outside, as described in Chapter 11.1, „Maintenance“, Pg. 26.

> The pump-motor unit must be delivered complete, i.e. not dismantled, Only the original packing should be used for shipment.

> The original rating plate of the pump-motor unit must be properly mounted, intact and legible.

All warranty claims are voided for pumpmotor units delivered for a damage expertise without the original rating plate or with a destroyed original rating plate.

## 11.5 Decontamination

 <b>WARNING</b>	
  	<p><b>Danger from flammable, caustic or toxic substances!</b></p> <p>To protect the environment and persons, the following applies: Pump-motor unit which have come into contact with dangerous substances must always be decontaminated before being</p>

## 12 Disposal

Have the entire pump-motor unit scrapped by a suitable disposal company. No special measures are required when doing so. For additional information on disposing of the unit, ask service.

## 13 Accessories

### 13.1 Flanges

The pipes on the intake and discharge side are connected to intake and discharge connections via the flanges. See Fig. 17, Pg. 31.

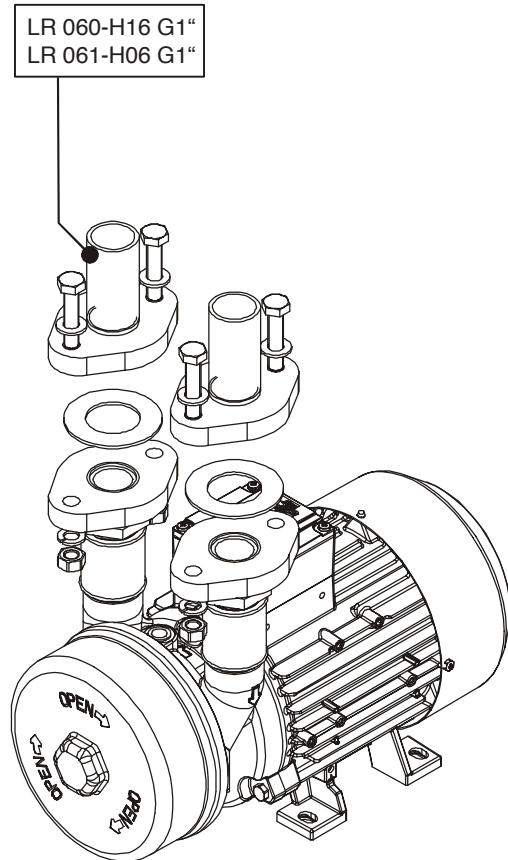

Obr. 17: Flanges

#### Mounting

The flanges are mounted when connecting the pipes/hoses, as described in Chapter 7.3, „Connecting pipes/hoses (vacuum pump/compressor)“, Pg. 17.

Proceed as follows:

- > Screwing flanges onto intake and discharge connections. Use commercially available liquid sealant (e.g. Loctite) when doing so. Tightening torque: dependent on the sealant.
- > Screw intake and discharge connections onto flanges. Use commercially available liquid sealant (e.g. Loctite) when doing so. Tightening torque: dependent on the sealant.

### 13.2 Non-return valve

The non-return valve is basically a valve with a plate seat. Its function is to prevent the pumped gases/vapors as well as the operating liquid from flowing back out of the pump in case the operation of the pump-motor unit is interrupted. It is mounted on the inlet connection of the unit for this purpose.

#### Mounting

The non-return valve is mounted when connecting the pipes/hoses, as described in Chapter 7.3, „Connecting pipes/hoses (vacuum pump/compressor)“, Pg. 25.

Proceed as follows:

Screw on the non-return valve with the arrow pointing downward on the inlet connection. Use commercially available liquid sealant (e.g. Loctite) when doing so. Tightening torque: dependent on the sealant.

> Screw the inlet pipe onto the non-return valve. Use commercially available liquid sealant (e.g. Loctite) when doing so. Tightening torque: dependent on the sealant.

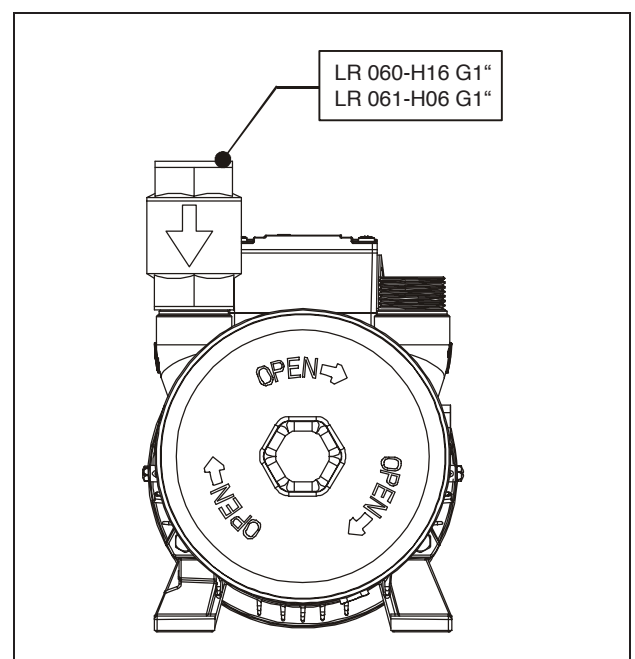

### 13.3 Gas ejector

The gas ejector is used when an inlet pressure of the unit in the range from 40 mbar [0.580 psi] to 10 mbar [0.145 psi] is to be achieved. The gas ejector compresses the pumped gases/vapors sucked in to the inlet pressure of the pump-motor unit. Ambient air at 20°C [68 °F] and 1013 mbar [14.7 psi] is used as a propellant. This air may not contain any liquid droplets.

See Fig. 19, Pg. 32.

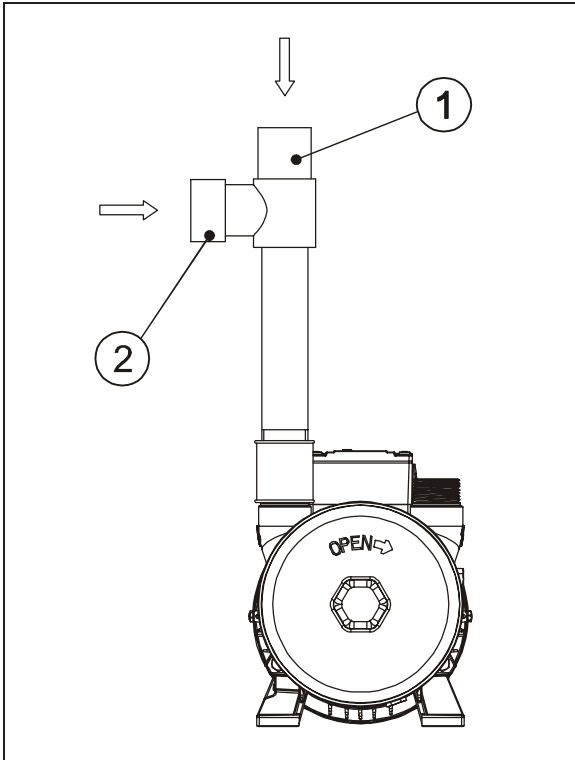

Fig. 19: Gas ejector

#### Mounting

The gas ejector is mounted when connecting the pipes/hoses, as described in Chapter 7.3, „Connecting pipes/hoses (vacuum pump/compressor)“, Pg. 17.

Proceed as follows:

- > Screw the gas ejector onto the inlet connection. Use commercially available liquid sealant (e.g. Loctite) when doing so. Tightening torque: dependent on the sealant.
- > Screw the inlet pipe onto the gas ejector. Use commercially available liquid sealant (e.g. Loctite) when doing so. Tightening torque: dependent on the sealant.
- > With soiled ambient air: Screw a propellant line onto the gas ejector.

When evacuating containers, the gas ejector operates as a throttle in the range from 1000 mbar [14.5 psi] to approx. 100 mbar [1.45 psi]. To achieve fast venting times here, the gas ejector can be bypassed with a bypass pipe. The bypass pipe must be closed if the gas ejector is to be effective. The best point for switching over to operation with the gas ejector is at approx. 40 mbar [0.580 psi].



### 13.4 Liquid separator

The liquid separator is mounted on the discharge connection. Its functions consists of separating the discharged operating liquid form the pumped gases/vapors. Part of this separated operating liquid can be fed back to the pump-motor unit via the operating-liquid port. The rest is drained off and replaced with fresh operating liquid.

Operation with a liquid separator and operating water return is the operating mode recommended for the pump-motor unit.

The procedure for mounting the liquid separator on the pump-motor unit is shown in Fig. 20, Pg. 34, and Fig. 21, Pg. 35.

Here the following applies:

- 1) Remove the plug at the top and bottom on the liquid separator.
- 2) Screw the hose nipple into the holes on the liquid separator. Use commercially available liquid sealant (e.g. Loctite) when doing so.

> Top hole:

Angled hose nipple.

> Bottom hole:

Straight hose nipple.

For LR 060-H16 a LR 061-H06: The premounted reducer on the liquid separator is required. Therefore:

> Remove the reducer from the liquid separator.

> Seal off thread. Use commercially available liquid sealant (e.g. Loctite) when doing so.

> Screw the reducer into the liquid separator again.

- 3) Screw the hose nipple into the hole provided on the pump-motor unit. Use commercially available liquid sealant (e.g. Loctite) when doing so.

- Operating-liquid port: Angled hose nipple, directed toward the front.

- Connection for cavitation protection: Angled hose nipple, directed upward.

- 4) Mount the „T“ hose nipple on the angled hose nipple on the operating-liquid port with the hose clamp.

- 5) Place the liquid separator on the discharge connection and tighten it by hand. Use commercially available liquid sealant (e.g. Loctite) when doing so.

- 6) Mount the hose for returning the operating liquid (see arrow) with hose clamps.

- On the liquid separator: Mount the hose on the lower hose nipple.

- On the pump-motor unit: Mount the hose on the side connection of the „T“ hose nipple (operating-liquid port).

- 7) Mount the cavitation-protection hose (see arrow) with hose clamps.

- On the liquid separator: Mount the hose on the upper hose nipple.

- On the pump-motor unit: Mount the hose on the hose nipple of the cavitation protection connection.

- 8) Side view of the mounted liquid separator.

A = Connection for feed pipe for fresh operating liquid.

B = Connection for draining off separated operating liquid.

### 13.5 Cavitation protection

Cavitation is understood to be the production and sudden implosion of gas bubbles in the liquid being fed. If the pressure in the vacuum pump/compressor drops below the evaporation pressure of the liquid (on the intake side or in constricted areas), gas bubbles form. When the pressure increases above the evaporation pressure again (on the discharge side or at points with a larger cross-section), these gas bubbles collapse while forming high pressure peaks, which may lead to particles being torn out of the housing wall and impeller. Noise is radiated. Material destruction of the pumpmotor unit is possible. To prevent this, measures should be taken for cavitation protection.

To protect the unit from cavitation, connect the cavitation-protection hose of the liquid separator to the connection for cavitation protection (Fig. 7, Pg. 17, Item 4).

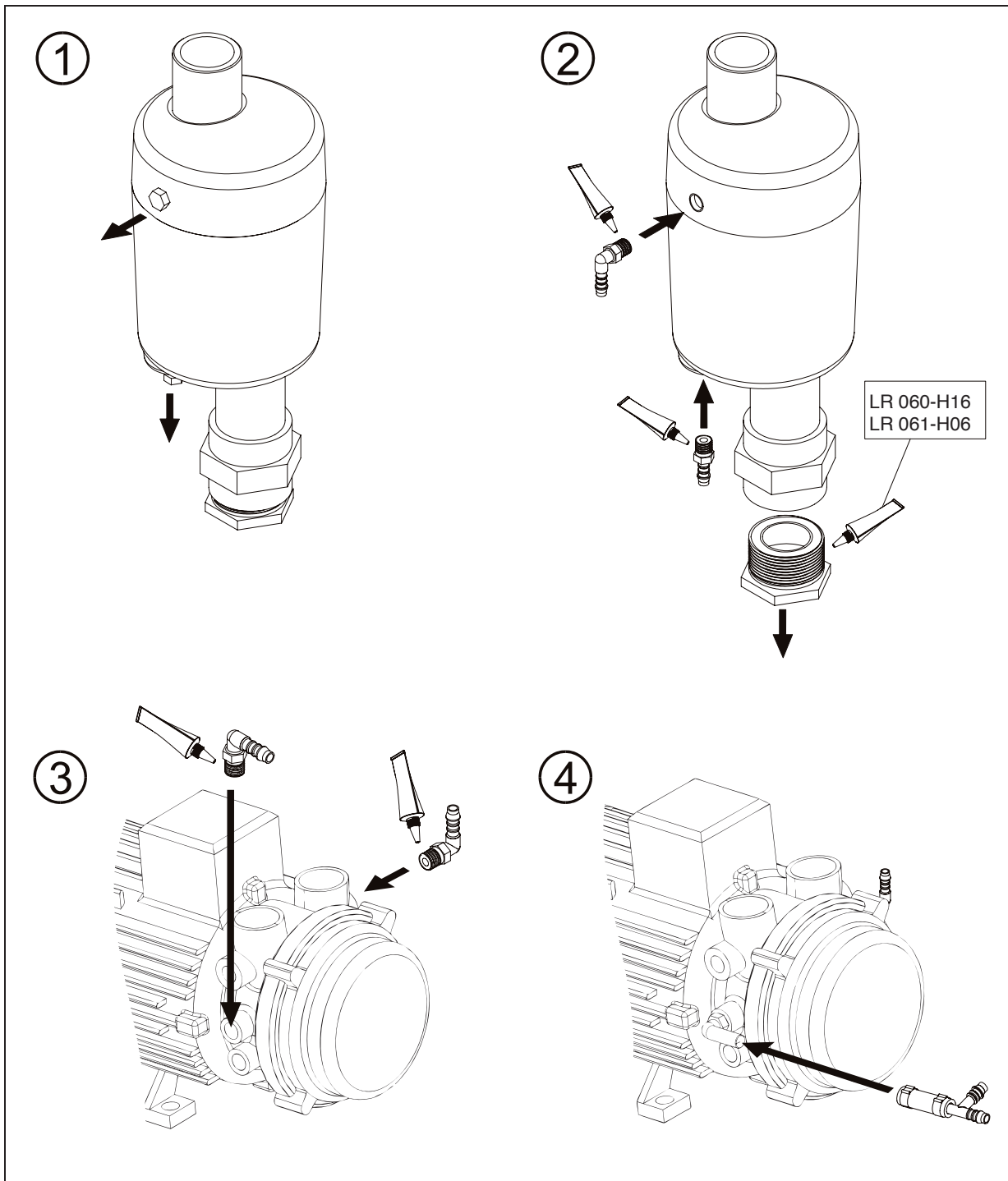

Fig. 20: Mounting liquid separator, Part 1 of 2

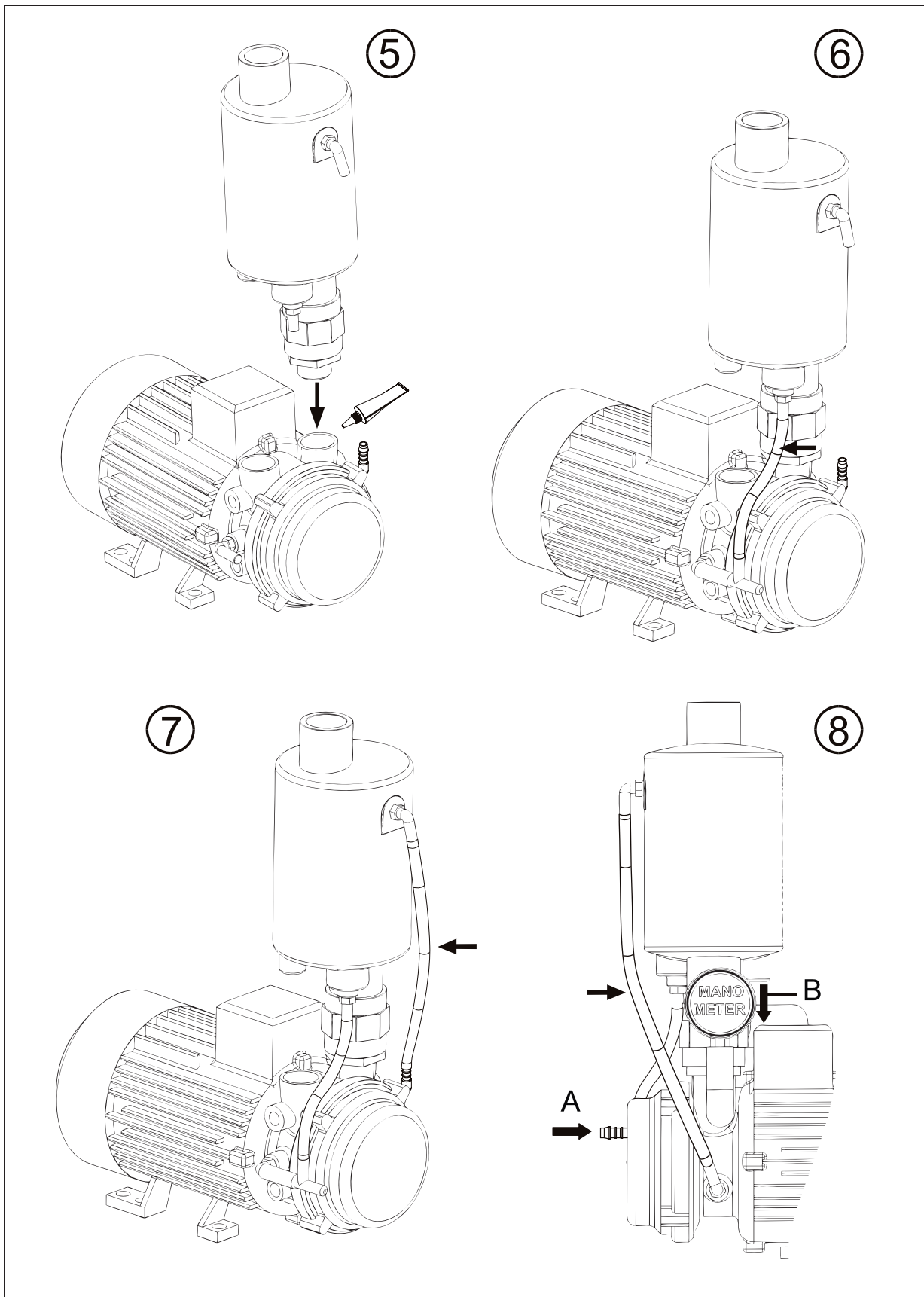

Fig. 21: Mounting liquid separator, Part 2 of 2

## 14 Exploded View with Parts List

### 14.1 Parts list

Part Item No.	Part Designation
001	Motor casing, complete
002	Vacuum pump/compressor housing
005	Motor rotor
006	Feather key
007	Deep-groove ball bearing
008	Deep-groove ball bearing
025	Screw
026	Motor mounting adapter
027	Circlip
033	Shaft sealing/CD ring
035	Mechanical seal
036	Washer
037	Spring-type straight pin
042	Terminal box, complete
045	Screw
047	Impeller
049	Port plate

Part Item No.	Part Designation
050	Valve plate
051	Intercepting plate
053	Special screw
058	O-ring
068	Screw plug
069	Sealing ring
072	Washer for cavitation protection
079	Screw plug
080	Sealing ring
095	Cover
125	Screw
127	Retaining ring
405	End shield
409	Nut
410	O-ring
451	Screw
452	Shaft sealing/CD ring
455	Spring strap*
459	Nut
467	Bearing screw-down set

Part Item No.	Part Designation
500	Fan guard
501	External fan
503	Special screw
505	Feather key
506	Circlip
640	Terminal-box upper section
641	Gasket
642	Screw
650	Terminal board, complete
651	Screw
661	Clamping strap
662	Lock washer
663	Screw
675	Nut
680	Terminal box lid
681	Gasket
682	Special screw
690	Blind plug
691	Blind plug

## 14.2 Exploded view

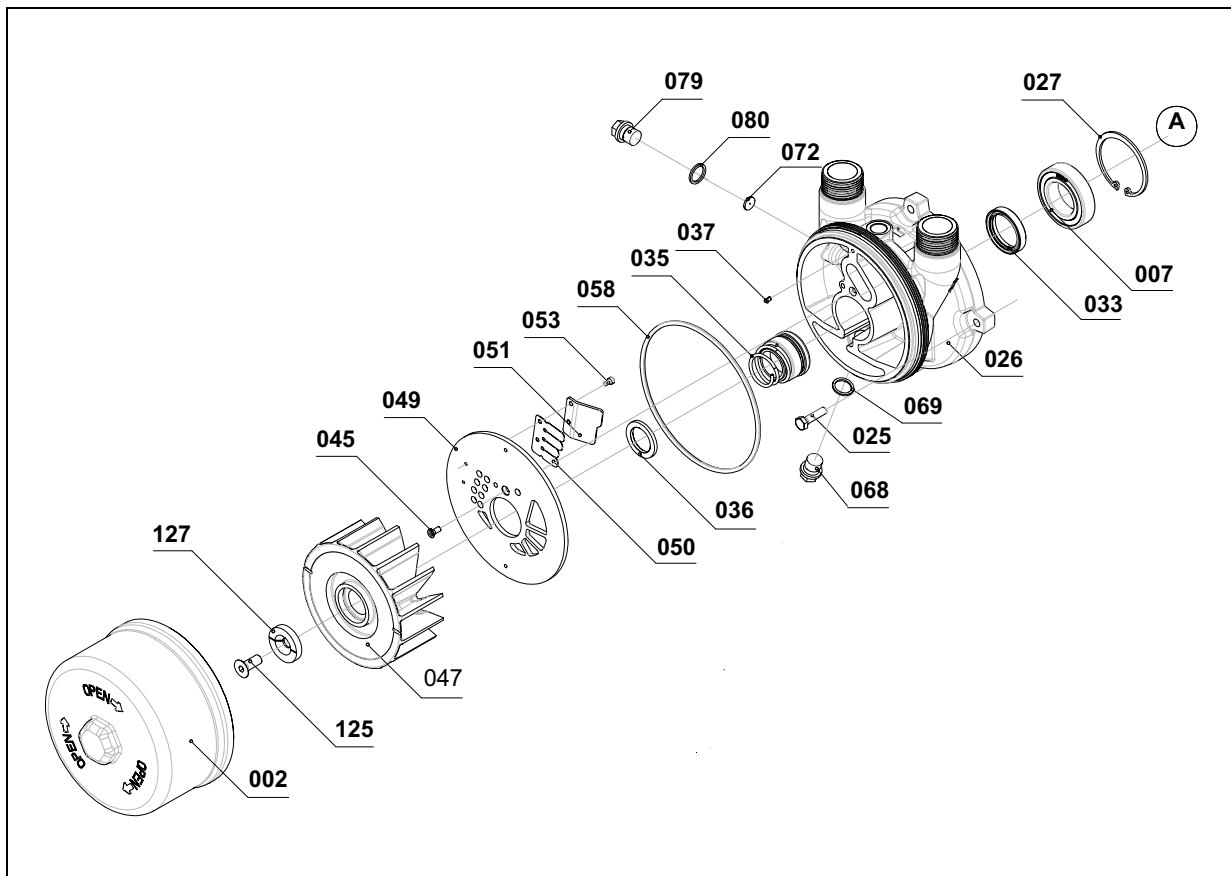

Fig. 22: Exploded view: vacuum pump/compressor section  
(Example, delivered version may differ in some details)

### 14.2 Exploded view: motor section

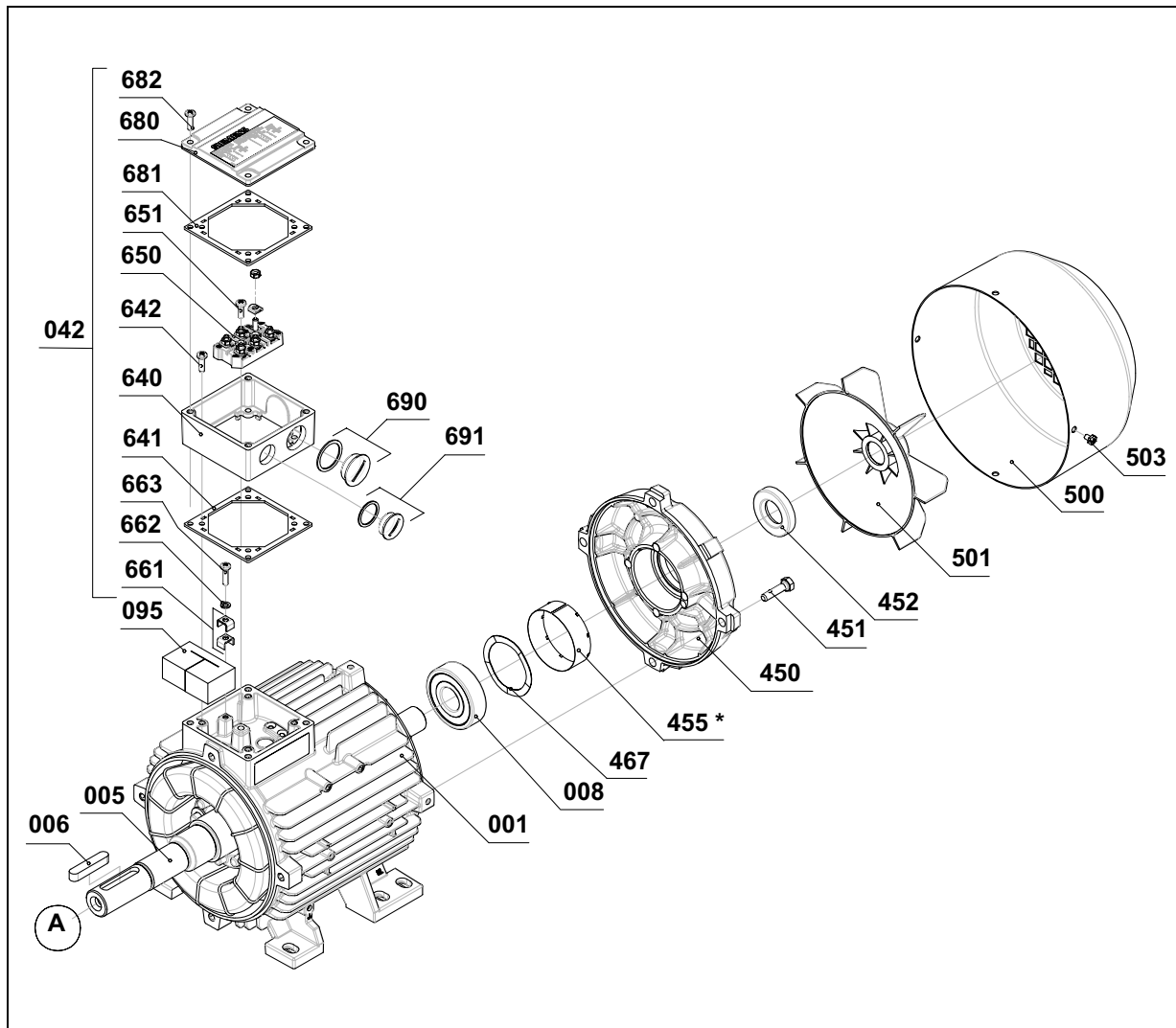

Fig. 23: Exploded view: motor section (Example, delivered version may differ in some details)

## 15 Limited standard warranty

IN-ECO company warrants that all products furnished by it are free from defects in material and workmanship at the time of shipment for a period of 18 months from the date of shipment, or 12 months from the date of installation, whichever occurs first. Claims must be made during that period and are limited to the replacement or repair of parts claimed to be defective..

In the case of components purchased by IN-ECO company , such as starters, controls, mechanical seals, motors, etc., the warranty of that manufacturer will be extended to the purchaser in lieu of any warranty by IN-ECO company. The replacement of wear items including, but not limited to, seals, bearings, drain plugs, fill plugs etc., made in connection with normal service are not covered by this Warranty.

The Limited Standard Warranty is valid only when the product has been properly installed, used in a normal manner, and serviced according to the operating manual. This warranty shall not extend to products that have been misused, neglected, altered, or repaired without factory authorization during the warranty period. We highly recommend the use of IN-ECO parts to achieve documented performance and efficient operation. The use parts other than IN-ECO could limit the life expectancy of the equipment and could void any warranties if they are the cause of any damage. Operating conditions beyond our control such as improper voltage or water pressure, excessive ambient temperatures, or other conditions that would affect the performance or life of the product will also cause the warranty to become void.

Permission to return parts for warranty repair must be obtained, and all returns must be prepaid to the factory. If, after examination, the product or part is found to be defective, it will be repaired or replaced on a no-charge basis and returned, FOB the factory. If it is determined that the Warranty has not been breached by IN-ECO company, then the usual charges for repair or replacement will be made, FOB the factory. Parts or products that are obsolete or those made to special order are not returnable.

This Limited Standard Warranty applies only to the above and is for the period set forth. IN-ECO company's maximum liability shall not, in any case, exceed the contract price for the product, part, or component claimed to be defective; and IN-ECO company assumes no liability for any special, indirect, or consequential damages arising from defective equipment.

**THERE ARE NO WARRANTIES IMPLIED OR EXPRESSED THAT EXTEND BEYOND THOSE CONTAINED IN THIS LIMITED STANDARD WARRANTY.**

## 16 Waste disposal

Valid legal waste management regulations must be observed for proper waste disposal.

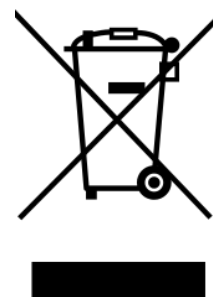

**INECO**

**IN-ECO**, spol. s r.o.  
Radlinského 13  
Ružomberok, 034 01  
**T** +421 44 430 46 62  
**E:** info@in-eco.eu  
**www.** in-eco.eu

27.12.2021